

Thyristor/Diode and Thyristor/Thyristor, 60A (ADD-A-PAK Power Modules)



ADD-A-PAK

FEATURES

- High voltage
- Glass passivated Chip
- Electrically isolated by DBC ceramic (Al_2O_3)
- 3000 V_{RMS} isolating voltage
- Industrial standard package
- High surge capability
- Modules uses high voltage power thyristors/diodes in two basic configurations
- Simple mounting
- UL approved file E320098
- Compliant to RoHS
- Designed and qualified for multiple level

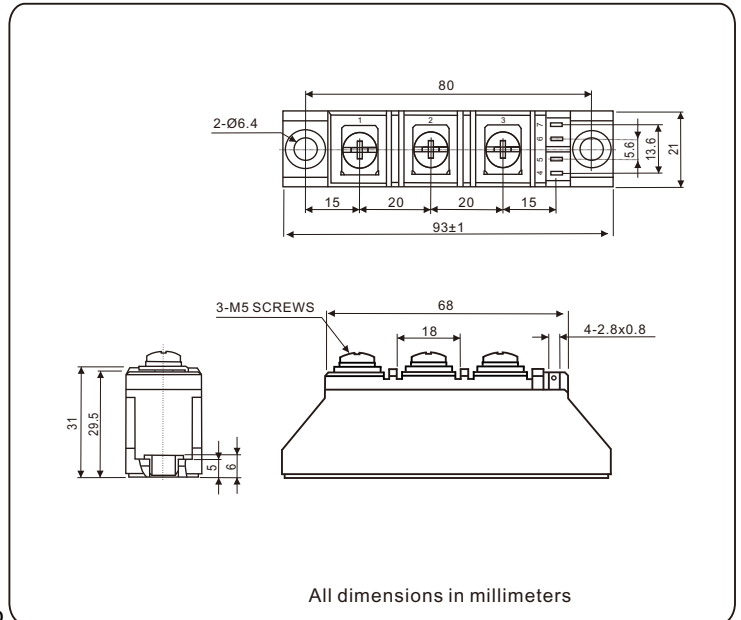

APPLICATIONS

- DC motor control and drives
- Battery charges
- Welders
- Power converters
- Lighting control
- Heat and temperature control

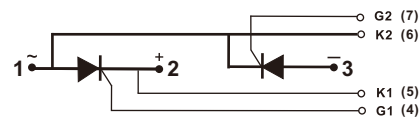

NKT

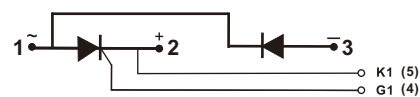

NKH

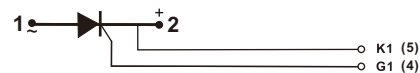

NKET

PRODUCT SUMMARY	
$I_{T(AV)} / I_{F(AV)}$	60 A

MAJOR RATINGS AND CHARACTERISTICS			
SYMBOL	CHARACTERISTICS	VALUE	UNITS
$I_{T(AV)} / I_{F(AV)}$	85 °C	60	A
$I_{T(RMS)} / I_{F(RMS)}$	85 °C	94	
I_{TSM} / I_{FSM}	50 Hz	1250	
	60 Hz	1313	
i^2_t	50 Hz	7.81	kA ² s
	60 Hz	7.13	
$i^2_{\sqrt{t}}$		78.1	kA ² √s
V_{DRM} / V_{RRM}	Range	400 to 1600	V
T_J	Range	-40 to 125	°C

ELECTRICAL SPECIFICATIONS

VOLTAGE RATINGS				
TYPE NUMBER	VOLTAGE CODE	V_{RRM}/V_{DRM} , MAXIMUM REPETITIVE PEAK REVERSE VOLTAGE V	V_{RSM}/V_{DSM} , MAXIMUM NON-REPETITIVE PEAK REVERSE VOLTAGE V	I_{RRM}/I_{DRM} AT 125 °C mA
NKT55..A NKH55..A NKET55..A	04	400	500	8
	08	800	900	
	12	1200	1300	
	14	1400	1500	
	16	1600	1700	

FORWARD CONDUCTION					
PARAMETER	SYMBOL	TEST CONDITIONS		VALUE	UNITS
Maximum average on-state current (thyristors)	$I_{T(AV)}$	180° conduction, half sine wave, $T_C = 85^\circ\text{C}$		60	A
Maximum average forward current (diodes)	$I_{F(AV)}$				
Maximum RMS on-state current	$I_{T(RMS)}$ $I_{F(RMS)}$	180° conduction, half sine wave, 50Hz, $T_C = 85^\circ\text{C}$		94	A
Maximum peak, one-cycle, on-state non-repetitive surge current	I_{TSM} I_{FSM}	t = 10 ms	No voltage reapplied	1250	
		t = 8.3 ms		1313	
		t = 10 ms	100% V_{RRM} reapplied	1050	
		t = 8.3 ms		1103	
Maximum I^2t for fusing	I^2t	t = 10 ms	No voltage reapplied	7.81	kA ² s
		t = 8.3 ms		7.13	
		t = 10 ms	100% V_{RRM} reapplied	5.51	
		t = 8.3 ms		5.05	
Maximum $I^2\sqrt{t}$ for fusing	$I^2\sqrt{t}$	t = 0.1 ms to 10 ms, no voltage reapplied		78.1	kA ² √s
Maximum value of threshold voltage	$V_{T(TO)}$	$T_J = T_J$ Maximum		1.05	V
Maximum value of on-state slope resistance	r_t			4.25	mΩ
Maximum on-state voltage drop	V_{TM}	$I_{TM} = 165\text{A}$, $T_J = 25^\circ\text{C}$, 180° conduction		1.6	V
Maximum forward voltage drop	V_{FM}	$I_{FM} = 165\text{A}$, $T_J = 25^\circ\text{C}$, 180° conduction		1.3	
Maximum holding current	I_H	Anode supply = 6V, resistive load $T_J = 25^\circ\text{C}$		150	mA
Maximum latching current	I_L			400	

BLOCKING					
PARAMETER	SYMBOL	TEST CONDITIONS		VALUES	UNITS
Maximum peak reverse and off-state leakage current	I_{RRM} I_{DRM}	$T_J = 125^\circ\text{C}$		8	mA
RMS isolation Voltage	V_{ISO}	50 Hz, circuit to base, all terminals shorted		2500 (1min) 3000 (1s)	V
Critical rate of rise of off-state voltage	dV/dt	$T_J = T_J$ Maximum exponential to 67 % rated V_{DRM}		1000	V/μs

TRIGGERING					
PARAMETER	SYMBOL	TEST CONDITIONS		VALUES	UNITS
Maximum peak gate power	P_{GM}	$t_p \leq 5 \text{ ms}, T_J = T_J \text{ maximum}$		10	W
Maximum average gate power	$P_{G(AV)}$	$f = 50 \text{ Hz}, T_J = T_J \text{ maximum}$		3	
Maximum peak gate current	I_{GM}	$t_p \leq 5 \text{ ms}, T_J = T_J \text{ maximum}$		3	A
Maximum peak negative gate voltage	$-V_{GM}$			10	V
Maximum required DC gate voltage to trigger	V_{GT}	$T_J = 25^\circ\text{C}$	Anode supply = 6 V, resistive load; $R_a = 1 \Omega$	0.7~1.5	
Maximum required DC gate current to trigger	I_{GT}			20~100	
Maximum gate voltage that will not trigger	V_{GD}	$T_J = T_J \text{ maximum}, 66.7\% V_{DRM} \text{ applied}$		0.25	V
Maximum gate current that will not trigger	I_{GD}			10	mA
Maximum rate of rise of turned-on current	di/dt	$T_J = 25^\circ\text{C}, I_{GM} = 1.5A, t_r \leq 0.5 \mu\text{s}$		150	A/ μs

THERMAL AND MECHANICAL SPECIFICATIONS					
PARAMETER	SYMBOL	TEST CONDITIONS		VALUES	UNITS
Maximum junction operating temperature range	T_J			- 40 to 125	°C
Maximum storage temperature range	T_{Stg}			- 40 to 150	
Maximum thermal resistance, junction to case per junction	R_{thJC}	DC operation		0.35	°C/W
Maximum thermal resistance, case to heatsink per module	R_{thCS}	Mounting surface, smooth, flat and greased		0.1	
Mounting torque $\pm 10\%$	AAP to heatsink, M6 busbar to AAP, M5	A mounting compound is recommended and the torque should be rechecked after a period of 3 hours to allow for the spread of the compound. Lubricated threads.		4	N.m
Approximate weight				120	g
				4.23	oz.
Case style				ADD-A-PAK	

ORDERING INFORMATION TABLE

Device code	NKT	55	/	16	A
	①	②	③	④	
①	- Module type: NKT for (Thyristor + Thyristor) module NKH for (Thyristor + Diode) module NKET for single Thyristor module				
②	- Current rating: $I_{T(AV)} / I_{F(AV)}$				
③	- Voltage code $\times 100 = V_{RRM}$				
④	- Assembly type, "A" for soldering type				

Fig.1 Peak on-state voltage vs. peak on-state current

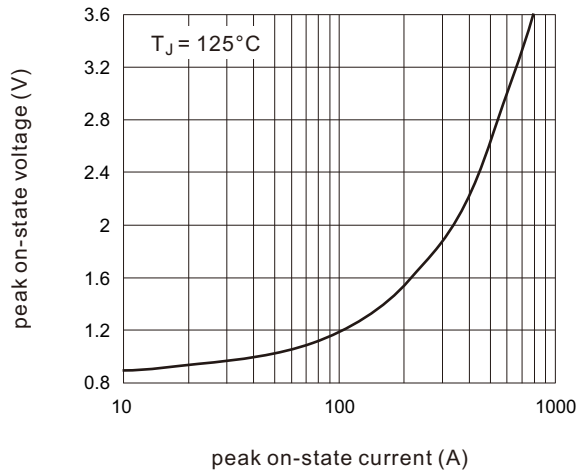

Fig.2 Max. junction to case thermal Impedance vs. time

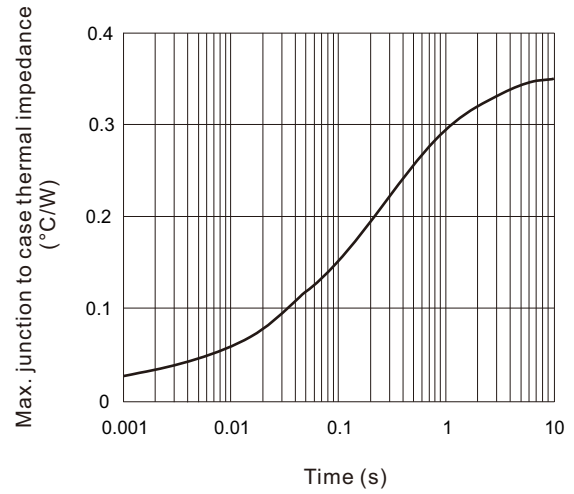

Fig.3 Power dissipation vs. average on-state current

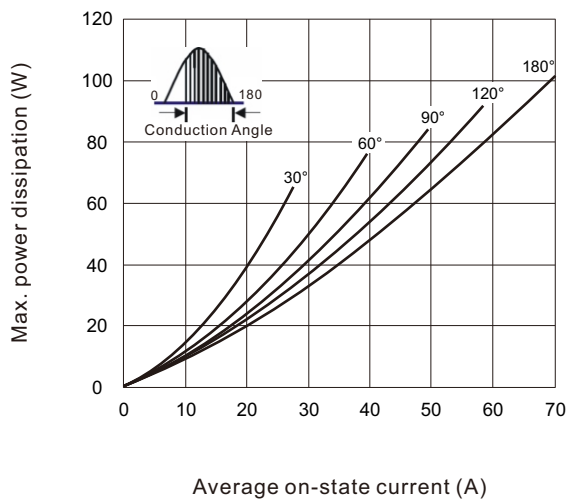

Fig.4 Case Temperature Vs. Average On-state Current

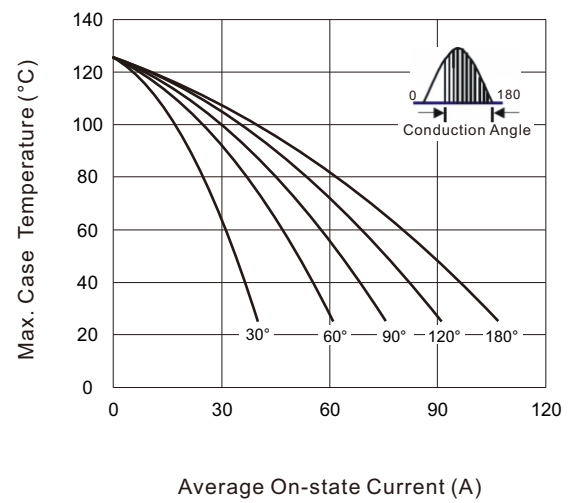

Fig.5 Surge on-state current vs. cycles

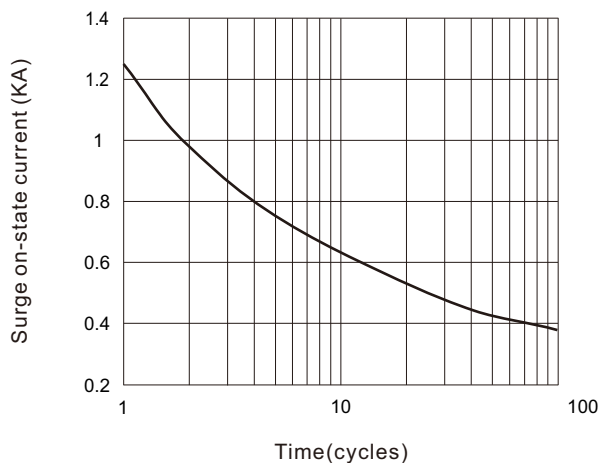

Fig.6 Gate characteristics

